

PSP4

DESCRIPTION

The Personal Switch Panel series is available with one to six keys.

The PSP integrates load relays for each key, each key is backlit by white or orange-green backlight. Due to its integrated microcontroller the PSP can either be used as a standalone unit or be connected to a TIA-485 data bus.

The standalone mode can be pinstrapped to switch the relay associated with the key in toggle or pushbutton mode.

When the PSP's data bus connected to the AlsterAero integrated Cabin Management System, key presses, key backlight dimming and relay switching are fully under CMS control. The relays as well as the backlight can be switched arbitrarily and independently from key presses. This allows for backlight coupling to cabin light dimming status, reusing the relays for arbitrary non keypress related functions.

The high quality milled metal bezel can be coated to customer request, the keyboard foil symbols and colours can be adapted to the functionality required.

An unique click-in variable depth mounting bracket makes installation and maintenance very ease. The PSP is sourced by 28VDC.

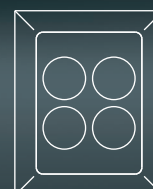
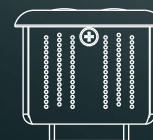

FEATURES

- four keys keyboard with click feedback
- white or orange-green dimmable backlight
- 2ADC load relays
- dual mode: standalone and CMS databus controlled
- pin strap for toggle / pushbutton standalone mode
- TIA-485 data bus, up to eight PSP connectable
- microprocessor control for customizable behaviour
- high quality milled metal surface
- high quality surface treatment of customer's preference
- fully customizable keyboard foil, any RAL colour possible
- click-in mounting frame

OUTLINE DRAWING

dimensions are millimeter (mm)

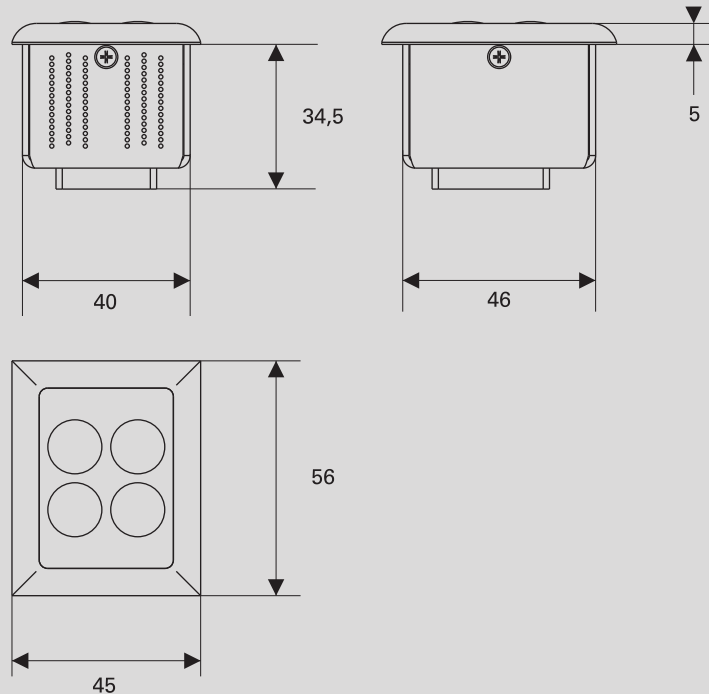

QUALIFICATION

- DO160

CONTACT

AlsterAero GmbH
Heidenkampsweg 43
20097 Hamburg
Germany

phone : +49 (0) 40 2482712 - 0
fax : +49 (0) 40 2482712 - 22



email : info@alsteraero.com
web : www.alsteraero.com